

FORD SCHOOL BUS APPLICATIONS



FD298 - '99 - '03 8 Cyl. E-350 Ford w/ 7.3L Diesel after 12-7-1998 138" - 176" W.B.



SB2-2389FT



M-1542



SB4-5462FT

FORD SCHOOL BUS APPLICATIONS

FD299 - '04 - '06 8 Cyl. Ford E-450 Van 6.0L 158" - 176" W.B.

Clamps

- ❶ SB2-A212FT-HGR
- ❷ H-450F
- ❸ H-450M
- ❹ H-450R

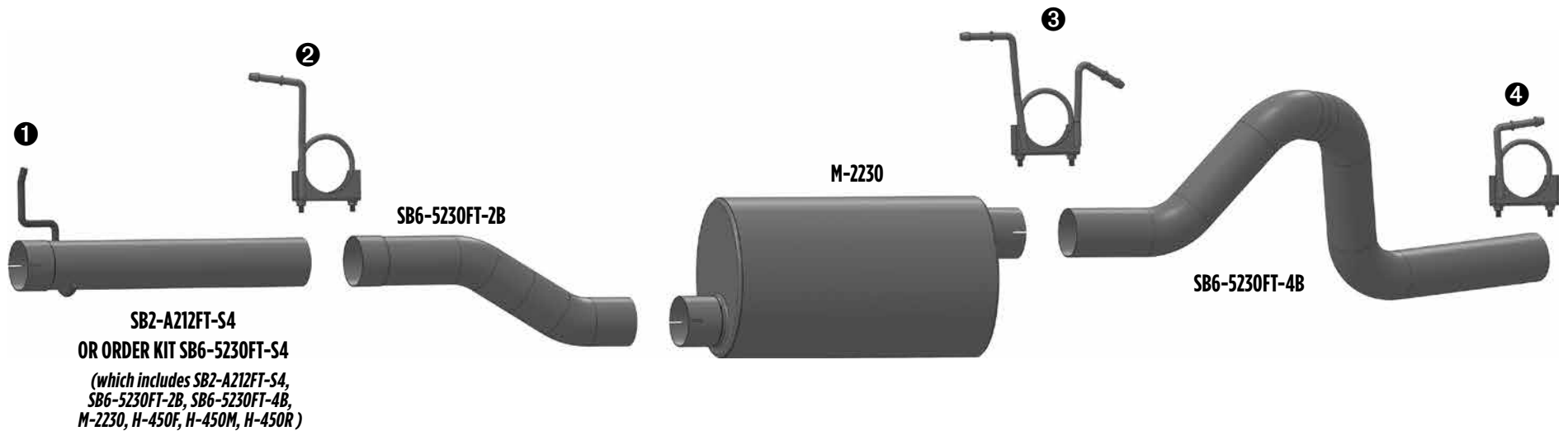

FD300 - '95 - '98 6 Cyl. B800, FD1060 w/ 5.9L Cummins Diesel; w/ Converter; Air Suspension; 151"-275" W.B.

Clamps

- ① VB-275C
- ② RMH-11
- ③ WFC-4SS

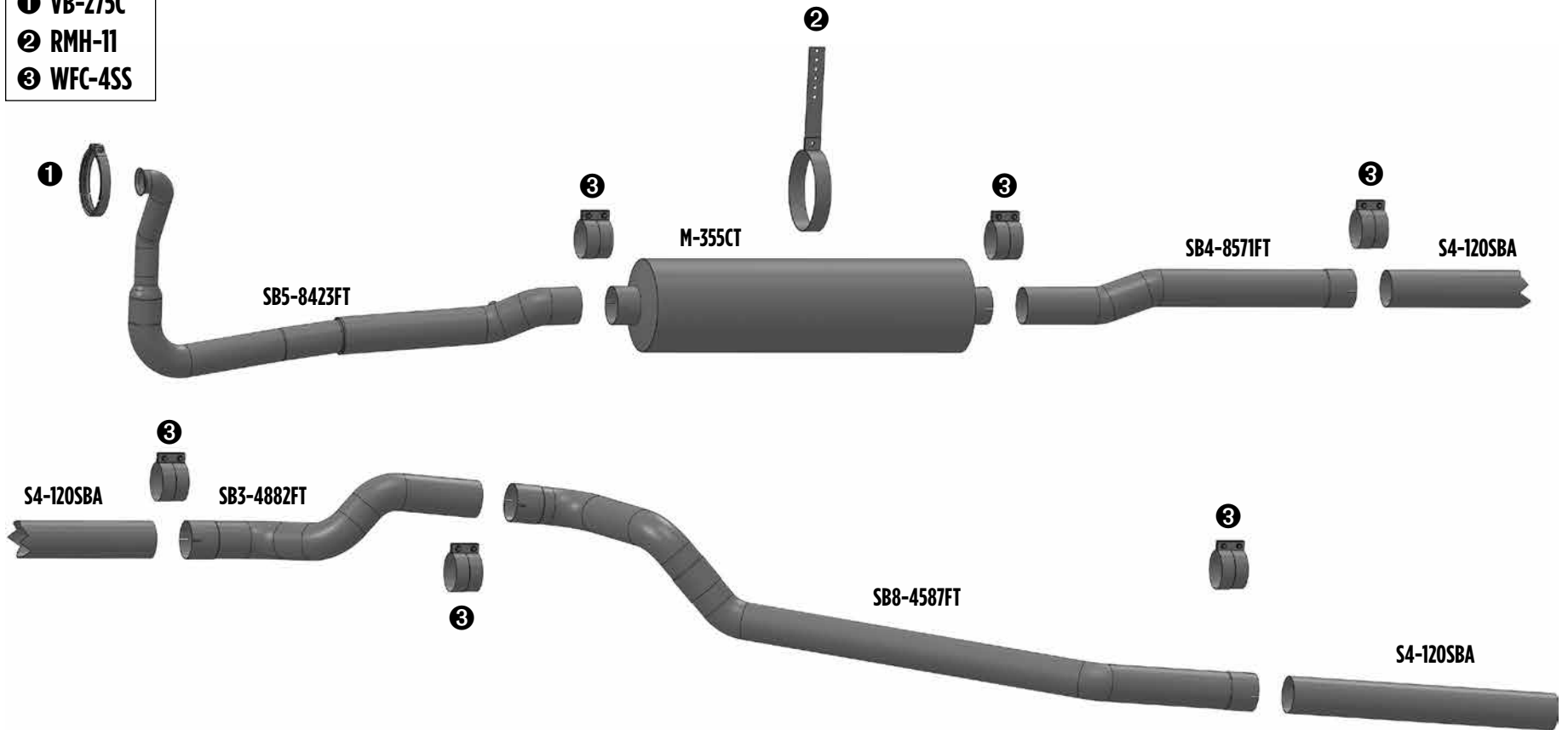

FORD SCHOOL BUS APPLICATIONS

FD301 - '92 - '98 6 Cyl. B600, B700, FD1060 Diesel Eng.; 5.9L; 216" W.B. and Shorter; 237" W.B. and Longer

Clamps

- ❶ VB-321C
- ❷ RMH-11
- ❸ WFC-4SS

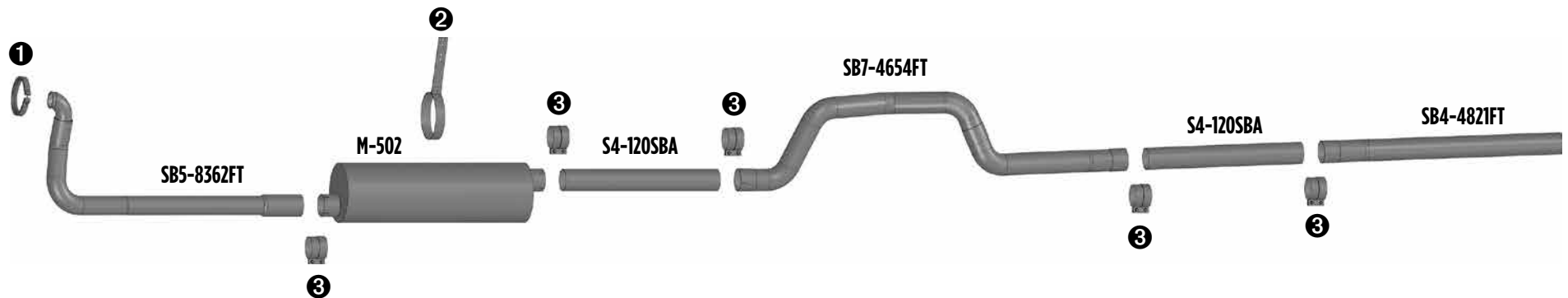

FD302 - '87 - '94 6 Cyl. B600, B700; 6.6L + 7.8L Diesel Eng.; Models Built Before 11-93

Clamps

- ① VB-321C
- ② RMH-11
- ③ WFC-4SS

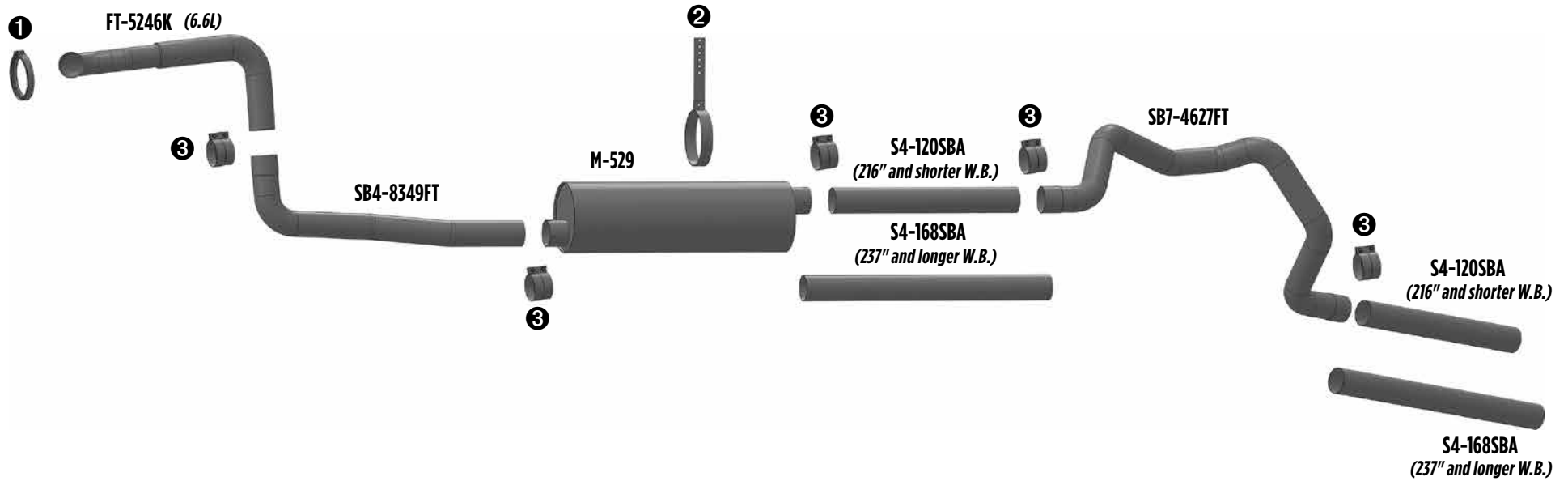

FREIGHTLINER SCHOOL BUS APPLICATIONS



FL399 - '02-'03 6 Cyl. FS65 Model w/ 900 Mercedes Diesel, Air Suspension

Clamps

- ❶ VB-460MB
- ❷ WFC-4SS
- ❸ H-FLM1

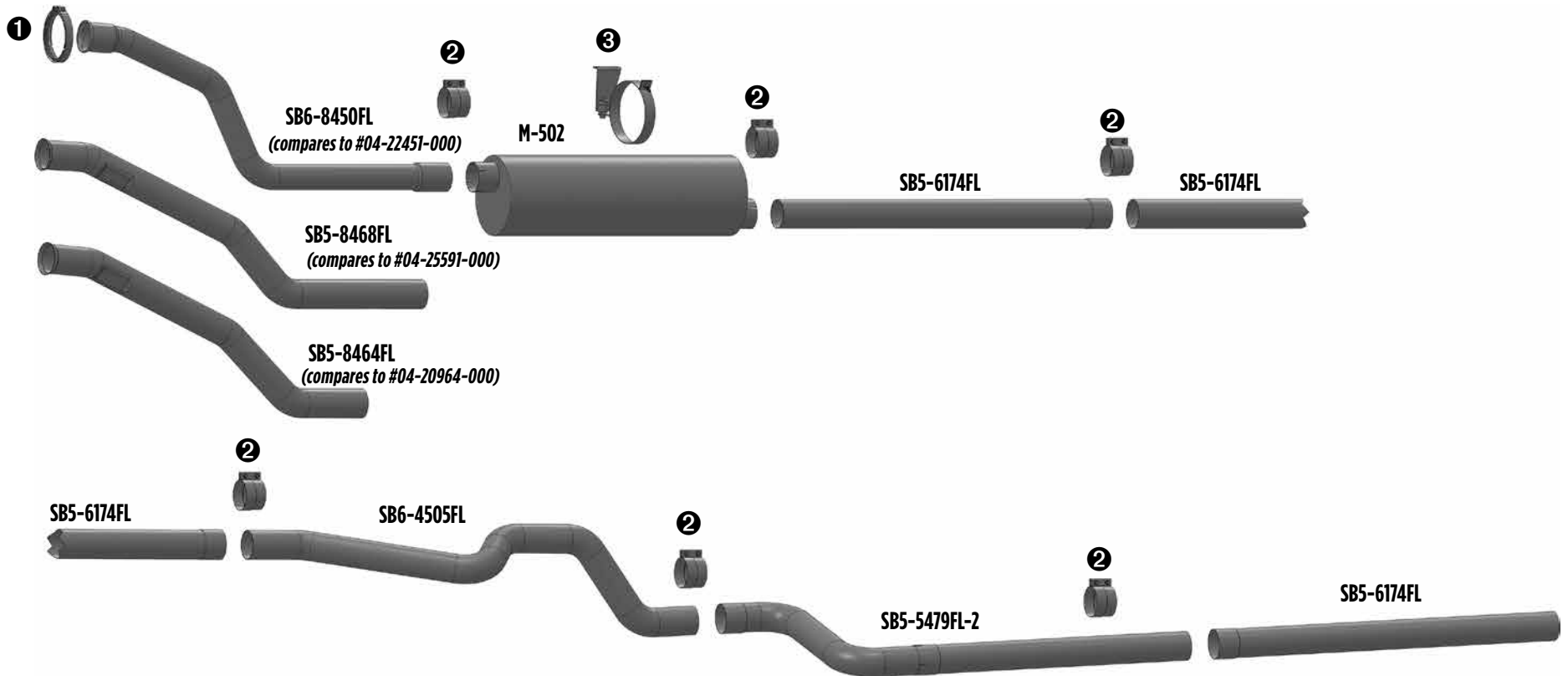

FL401 - '02 - '04 4-6 Cyl. Mercedes Engine Air Ride Suspension

Clamps

- ① VB-460M (6 Cyl.)
- ② H-FLP1
- ③ WFC-4SS
- ④ WFC-3SS
- ⑤ H-FLM1
- ⑥ H-FLP3
- ⑦ VB-390MB (4 Cyl.)

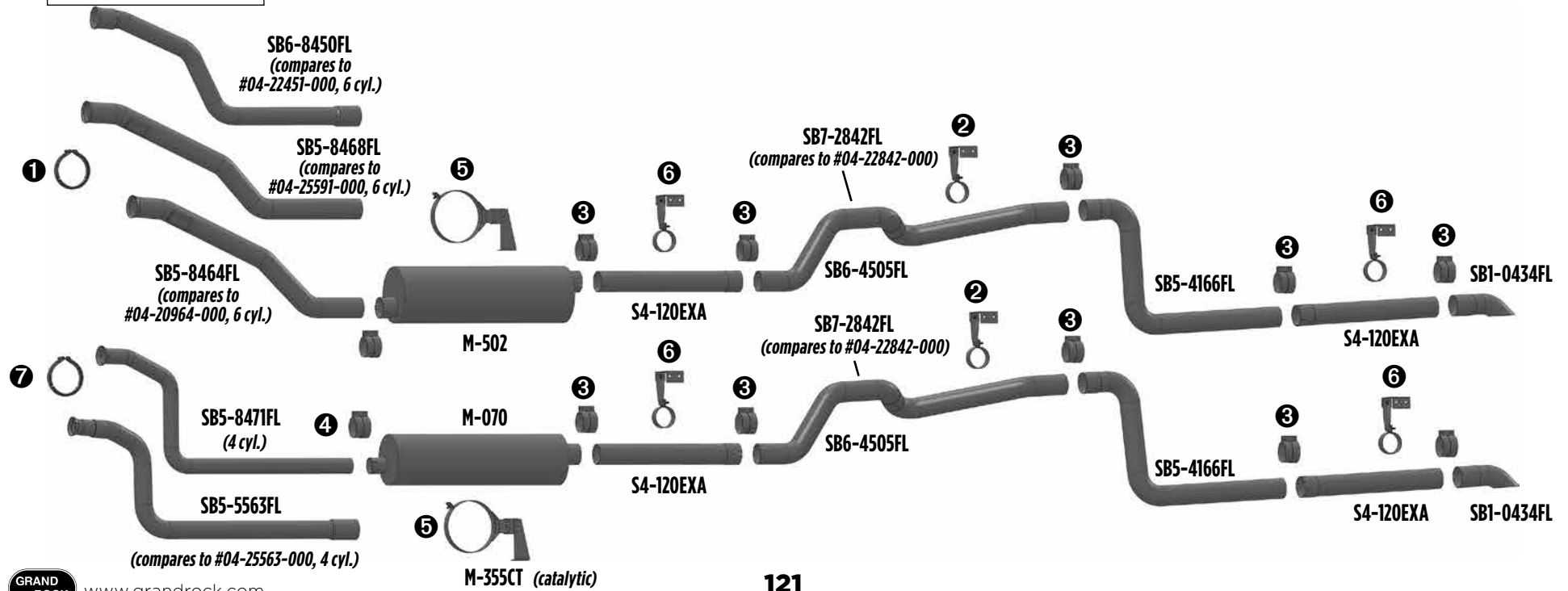

FL402 - '02 - '04 6 Cyl. B-Series Cummins Engine w/ World Trans

Clamps

- ① VB-321C
- ② H-FLM1
- ③ WFC-3SS
- ④ WFC-4SS
- ⑤ H-FLP3

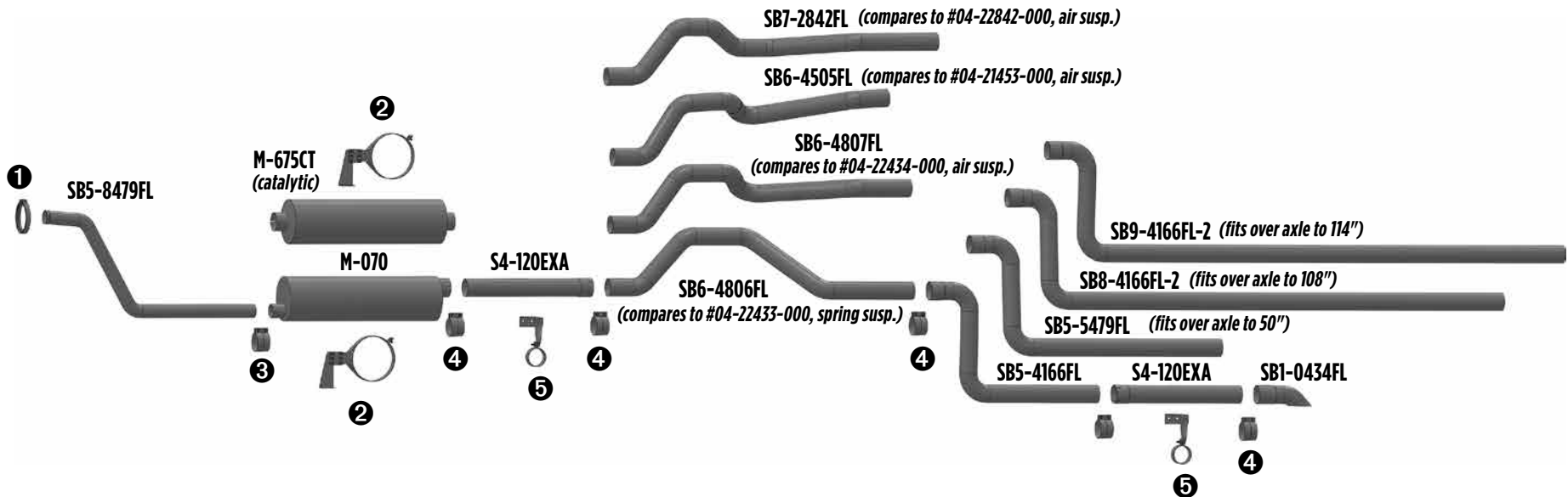

FL403 - '02 - '04 6 Cyl. w/ 3126 Caterpillar Engine Air Suspension

Clamps

- ① VB-475C
- ② H-FLM1
- ③ H-FLP3
- ④ H-FLP1
- ⑤ WFC-4SS

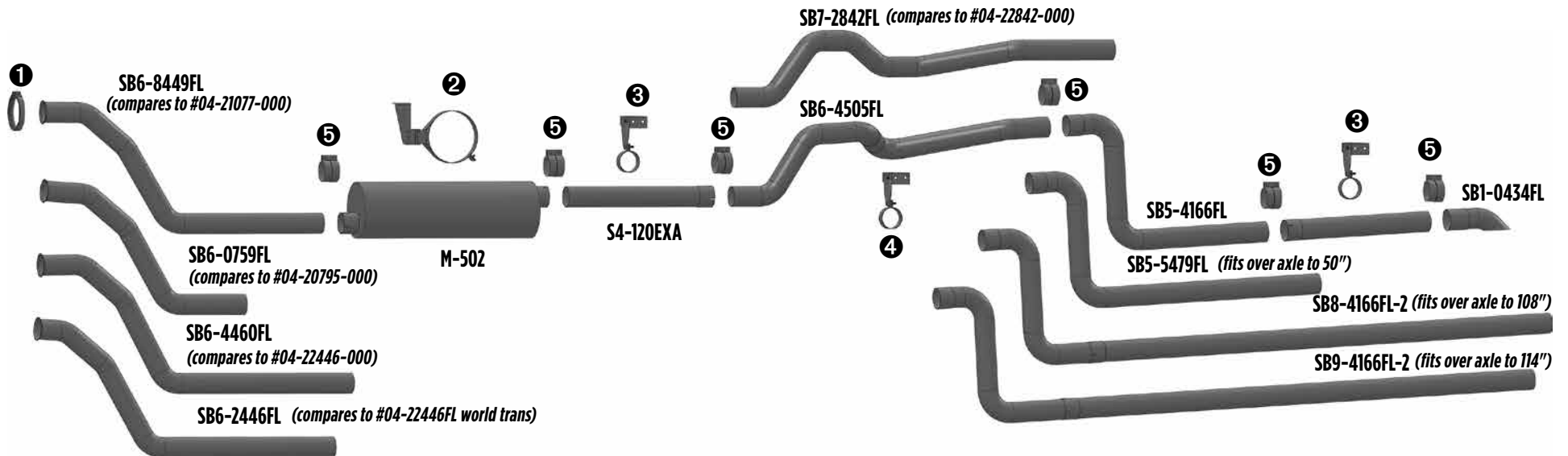

FL404 - '05 - '09 4-6 Cyl. Mercedes Engine Air Suspension EXC DPF Systems

Clamps

- ❶ VB-390MB
- ❷ VB-460MB
- ❸ H-FLM1
- ❹ H-FLP1
- ❺ H-FLP3
- ❻ WFC-4SS

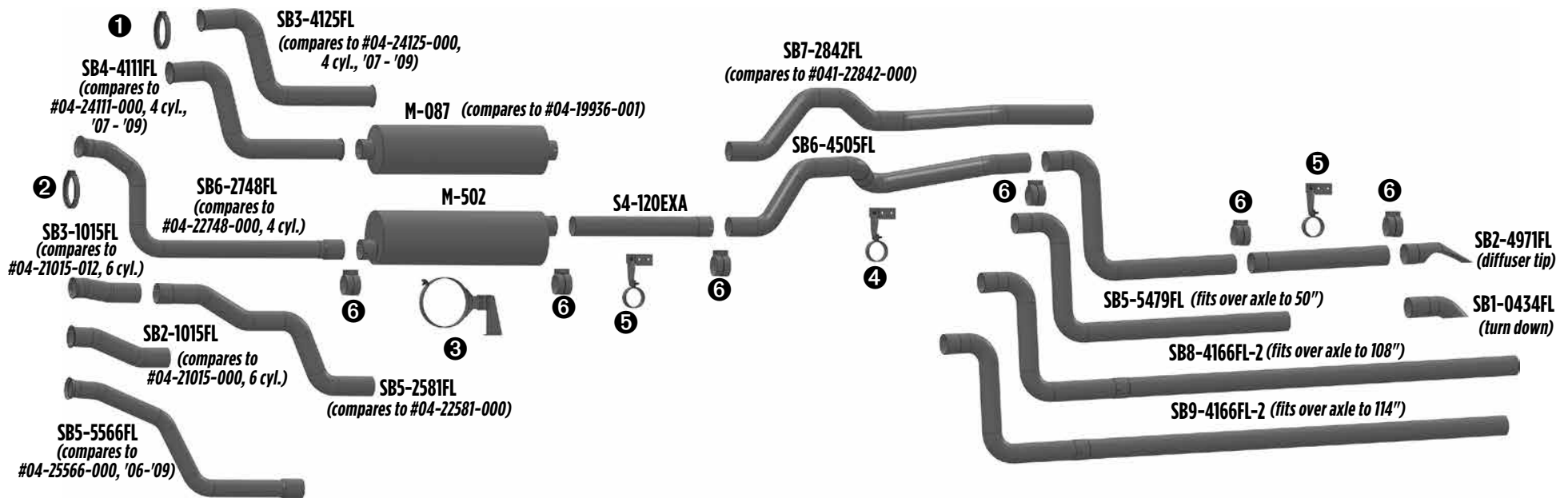

FREIGHTLINER SCHOOL BUS APPLICATIONS

FL405 - '98 - '01 6 Cyl. B Series Cummins Engine

Clamps

- ① VB-321C
- ② WFC-3SS
- ③ H-FLM1
- ④ H-FLP3
- ⑤ WFC-4SS
- ⑥ H-FLP4
- ⑦ H-FLP5

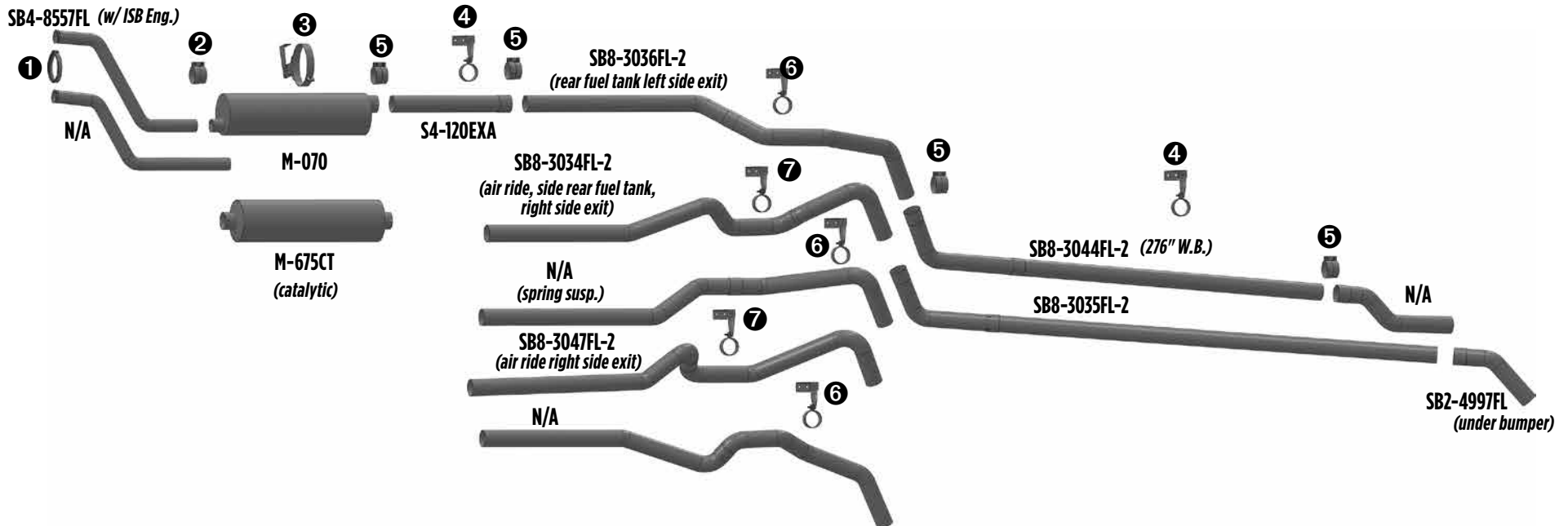



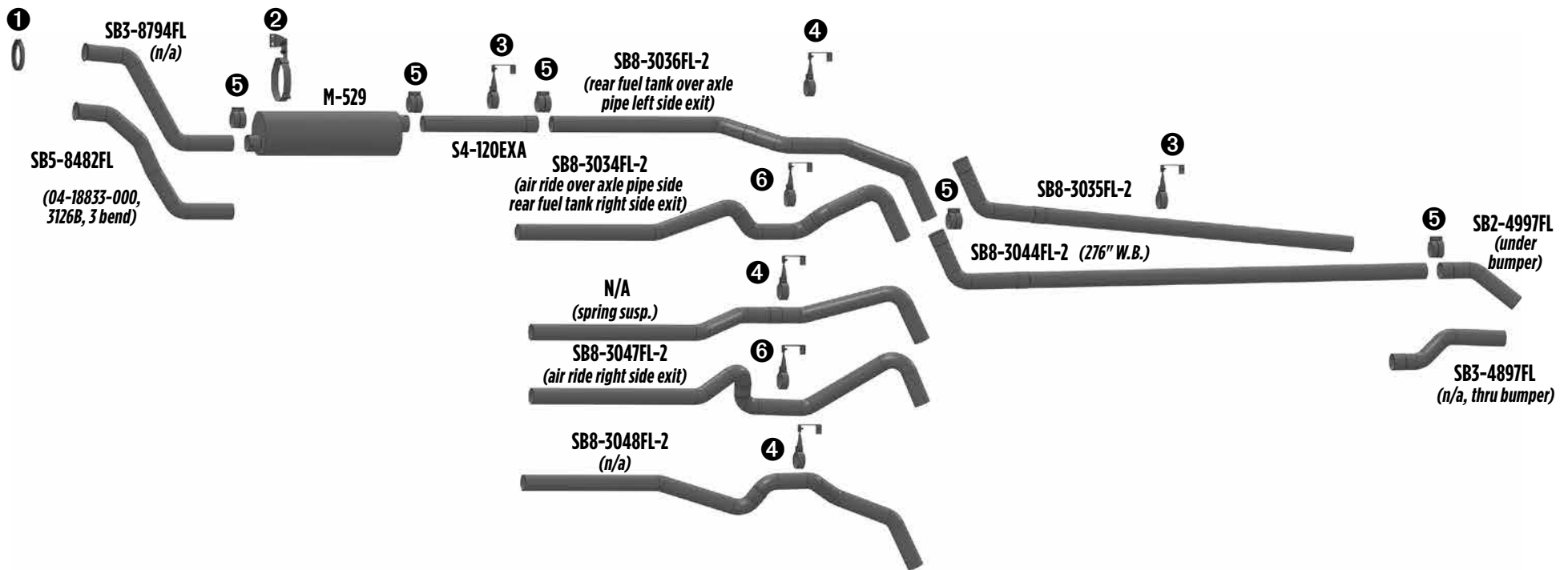

FL406 - '98 - '01 6 Cyl. 3126 Caterpillar Engine

Clamps

- ❶ VB-461D
- ❷ H-FLM1
- ❸ H-FLP3
- ❹ H-FLP4
- ❺ WFC-4SS
- ❻ H-FLP5



UNIVERSAL NEW PARTS 2013

	GRAND ROCK PART NO.	OE PART NO.	DESCRIPTION	2 PIECE PIPE 2nd PART NEEDED
	SB11-2438FL	04-22438-005	S4-130EXA	
	SB2-5375FL		FL/IH MUFFLER OFFSET PIPE 3126 CAT MUFFLER	
	SB3-0537FL	04-20537-000	98 AND UP FREIGHTLINER TAILPIPE EXTENSION; 4" ALZ 2 BEND OD/ID	
	SB5-1454FL	04-21454-000	02-UP FREIGHTLINER OVERAXLE SPRING SUSPENSION; 4" ALZ 4 BEND PIPE OD/OD	
	SB7-2843FL	04-22843-000	02 AND UP FREIGHTLINER REAR OVERAXLE SPRING SUSPENSION; 4" ALZ 4 BEND PIPE OD/OD	